

# 5~16V转3.8V, 3.8V转3.3V电路

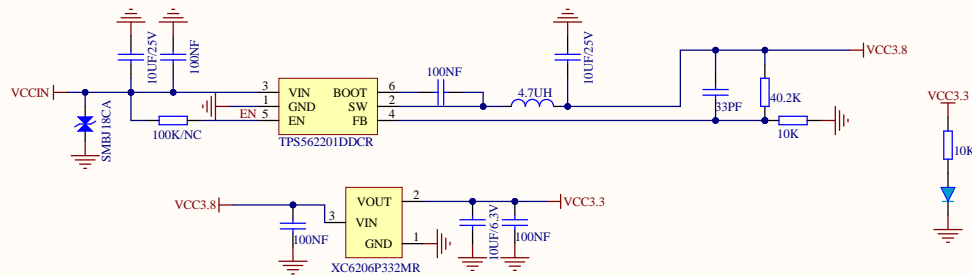

# ME3630/GM510/GM191

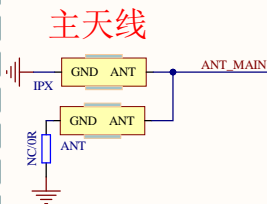

### 分集天线



### GNSS天线

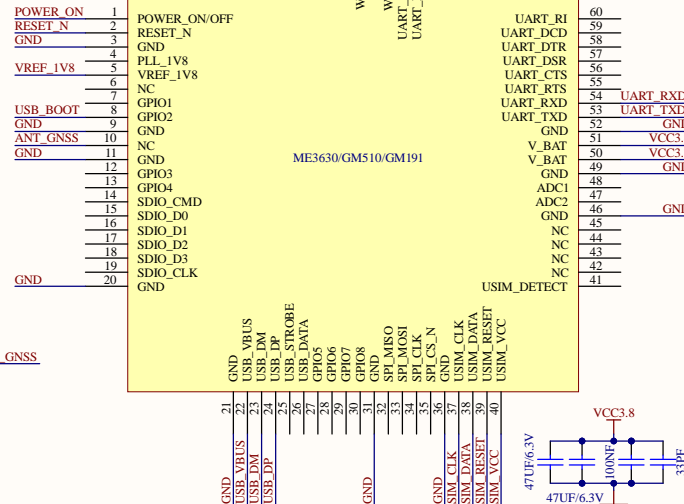
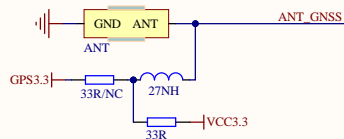

# 接口电路

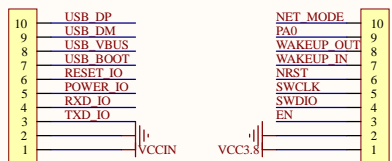

# UART电平转换电路

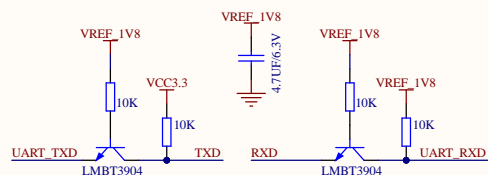

# 定位孔



# 开关机电路 复位电路

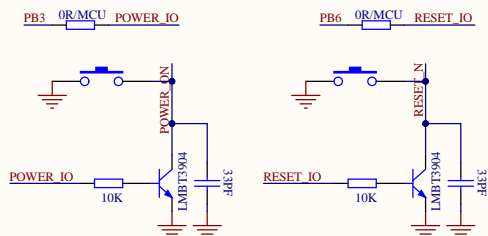

注：复位至少拉低1秒  
注：开机0.2秒，关机3秒

# GNSS电源

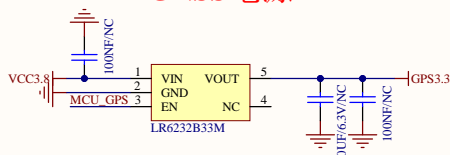

# 串口选择

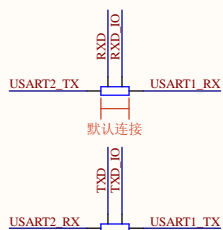

# MCU

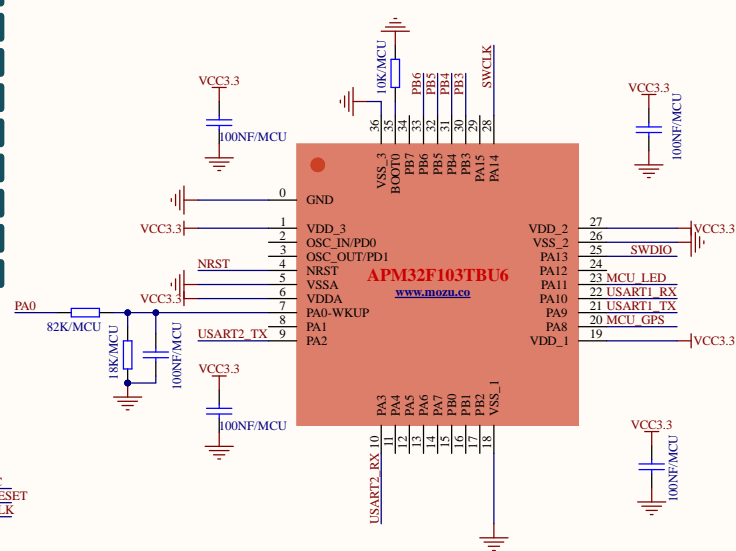

# 状态指示灯

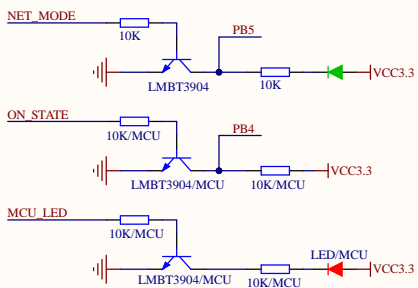

# NanoSIM卡电路

